ASSIST *recommends...*

Recommendations for Evaluating Parking Lot Luminaires

Volume 7, Issue 3
January 2009
Revised January 2010

A publication of the Alliance for Solid-State Illumination Systems and Technologies

Lighting
Research Center



Copyright © 2009, 2010 by the Alliance for Solid-State Illumination Systems and Technologies (ASSIST).

Published by the Lighting Research Center, Rensselaer Polytechnic Institute, 21 Union St., Troy, NY 12180, USA. Online at <http://www.lrc.rpi.edu>.

All rights reserved. No part of this publication may be reproduced in any form, print, electronic, or otherwise, without the express permission of the Lighting Research Center.

This *ASSIST recommends* was prepared by the Lighting Research Center at the request of the Alliance for Solid-State Illumination Systems and Technologies (ASSIST). The recommendations set forth here are developed by consensus of ASSIST sponsors and the Lighting Research Center. ASSIST and the Lighting Research Center may update these recommendations as new research, technologies, and methods become available.

Check for new and updated *ASSIST recommends* documents at:

<http://www.lrc.rpi.edu/programs/solidstate/assist/recommends.asp>

ASSIST Sponsors

Acuity Brands Lighting
Bridgelux
China Solid State Lighting Alliance
Cree
Everlight Electronics Co., Ltd.
Federal Aviation Administration
GE Lumination
ITRI, Industrial Technology Research Institute
Lighting Science Group
Lite-On
NeoPac Lighting
New York State Energy Research and Development Authority
OSRAM SYLVANIA / OSRAM Opto Semiconductors
Permlight
Philips Color Kinetics
Photonics Cluster (UK)/The Lighting Association
Seoul Semiconductor
Sharp Laboratories of America
United States Environmental Protection Agency
USG
WAC Lighting

Lighting Research Center Technical Staff *(in alphabetical order)*

Jean Paul Freyssinier, Nadarajah Narendran, Jennifer Taylor, Yutao Zhou

Contents

Document Revision History	4
January 2010 revision	4
Introduction	5
Introduction	5
Background	5
Photometric Distributions of Outdoor Luminaires	6
Traditional Metrics	7
Proposed Alternative Metric	8
Luminaire System Application Efficacy	8
Defining the Task Plane	9
Range of Illuminance Values	9
Penalizing Non-conforming Cells	10
The New Metric	11
Extending the LSAE Metric to Defined Parking Lot Areas	11
Evaluation Method	12
Luminaire System Application Efficacy (LSAE)	12
Step 1: Obtain the intensity distribution of the luminaire under evaluation	12
Step 2: Calculate the illuminance values on the task plane	12
Step 3: Calculate LSAE	17
CCT, CRI, and Chromaticity	18
Glare and Uplight	18
Mesopic Characterization of Outdoor Lighting	18
Extension to Multiple Poles, Luminaires and Application Configurations	19
Correlating LSAE to Energy Usage	22
Summary	23
Online Calculator	24
References	25
Acknowledgments	26
About ASSIST	26
Appendix: Sample Calculation and Report Form	27

Document Revision History

Summarized below are the major changes made to this *ASSIST recommends* document during each revision. The most recent revision supersedes all previous versions.

January 2010 revision

This revision adds new analyses and calculation methods for using the Luminaire System Application Efficacy (LSAE) metric to evaluate multiple luminaires per pole and multiple poles within a parking lot; and for correlating LSAE values to energy usage.

The revision also includes information about trade-offs between optimizing the pole mounting height for a given luminaire and optimizing the LSAE value.

Introduction

This document details a recommendation for testing and evaluating the photometric performance of parking lot luminaires for all light source technologies. The evaluation is based on the effectiveness of luminaires at meeting predetermined, application-based photometric criteria. Additionally, the metric described here can be used as one tool in the process of selecting or rank ordering luminaire choices for a parking lot.

This recommendation was developed by the Lighting Research Center (LRC) at Rensselaer Polytechnic Institute in collaboration with members of the Alliance for Solid-State Illumination Systems and Technologies (ASSIST). The suggested audience for this document is parking lot luminaire manufacturers, parking lot lighting designers and specifiers, and luminaire purchase decision-makers.

Background

The IESNA Lighting Handbook defines a luminaire as “a device to produce, control, and distribute light. It is a complete lighting unit consisting of the following components: one or more lamps, optical devices designed to distribute the light, sockets to position and protect the lamps and to connect the lamps to a supply of electric power, and the mechanical components required to support or attach the luminaire” (Rea 2000).

Well-designed parking lot lighting should provide users with an appropriate adaptation luminance level and sufficient target contrast for the specific application. It should also provide high uniformity of surface luminance and accommodate visual needs under mesopic lighting conditions. It should facilitate identification of objects, obstacles and individuals, as well as peripheral detection. It should also minimize glare (direct and reflected), light pollution/trespass, and make the appearances of spaces appealing. It should have a low installation cost, consume as little electric energy as possible, and require as little maintenance as possible, so as to minimize the total cost of ownership.

Generally, the luminaire design (e.g., the optics used to transfer the luminous flux from the light source to the application task area and the housing with proper thermal management) influences the overall light output, luminous efficacy, color, and life of the total system. Ultimately, the most useful performance characteristics for the end user are: (1) the amount of luminous flux exiting the luminaire within the optical beam that illuminates the task and helps meet the lighting requirements; (2) the color of the light within the optical beam; and (3) the system (lamp, ballast [or driver]) life when used in an application. Further, to allow users to make meaningful comparisons between products, performance metrics developed for lighting applications must be technology-independent.

This document recommends an alternative photometric performance metric for parking lot luminaires. The goal of this metric is to allow for the comparison of two or more luminaires under the same conditions. The metric presented in this document is not meant to be a substitute for complete system analysis. Other factors may influence the selection of light source and luminaire options, such as cost, availability, spectral power distribution, life, etc.

Photometric Distributions of Outdoor Luminaires

Parking lot lighting installations often use luminaires mounted on post-top brackets or on short arms that may be arranged in single, twin, triple, or quad configurations. The configuration depends on the illumination goals of the application, the mounting location of the poles (i.e., near the edge or near the center of the area), and the photometric distribution of the luminaires. Borrowing from the definitions used in roadway lighting, the photometric distribution of parking lot luminaires can be classified in respect to three criteria: lateral light distribution, vertical light distribution, and control of light distribution above maximum intensity (Rea 2000). The lateral light distribution of a luminaire is classified as one of the following: Type I, II, III, IV or V. Type V luminaires are the only lateral distribution type with axially symmetric or quadrilaterally symmetric distributions. Types I, II, III and IV have bilaterally symmetric distributions. Types I and V are typically used at or near the center of the area to illuminate, whereas Types II, III and IV are typically used at or near the edge of the area to illuminate.

The vertical light distribution of the luminaire is classified as Short, Medium, or Long. Finally, although traditional classifications of light distribution above maximum intensity for glare and light pollution evaluation (i.e., full cutoff, cutoff, semi-cutoff, and non-cutoff) are being phased out, some commercial literature still use these terms. A new and more comprehensive classification is now available in the IESNA's *TM-15-07 Luminaire Classification System for Outdoor Luminaires* (IESNA 2007a). Further, the publication *Addendum A for TM-15-07* defines ratings for backlight (B), upright (U) and glare (G) that may be indicative of the optical control of the luminaire (IESNA 2007b). These ratings have come to be known in the industry as "BUG ratings" and are based on zonal lumen calculations for angles established in publication TM-15-07 (IESNA 2007a). The zonal lumen thresholds that define the ratings are available in *Addendum A for IESNA TM-15-07* (IESNA 2007b).

The geometry used to classify the luminaires by lateral and vertical distributions is shown in Figures 1 and 2.

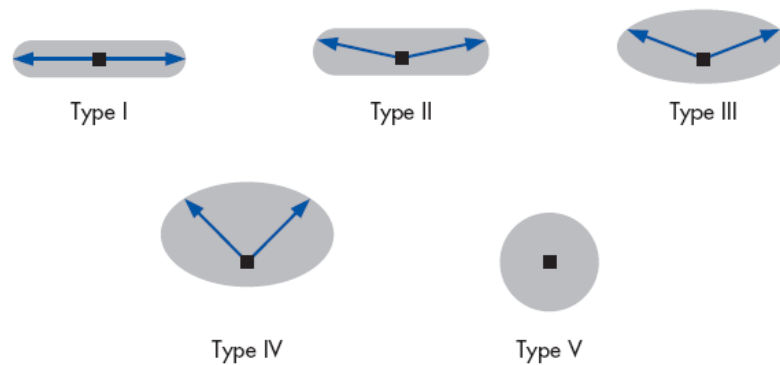

Figure 1. IESNA lateral light distribution classification types (NLPIP 2004).

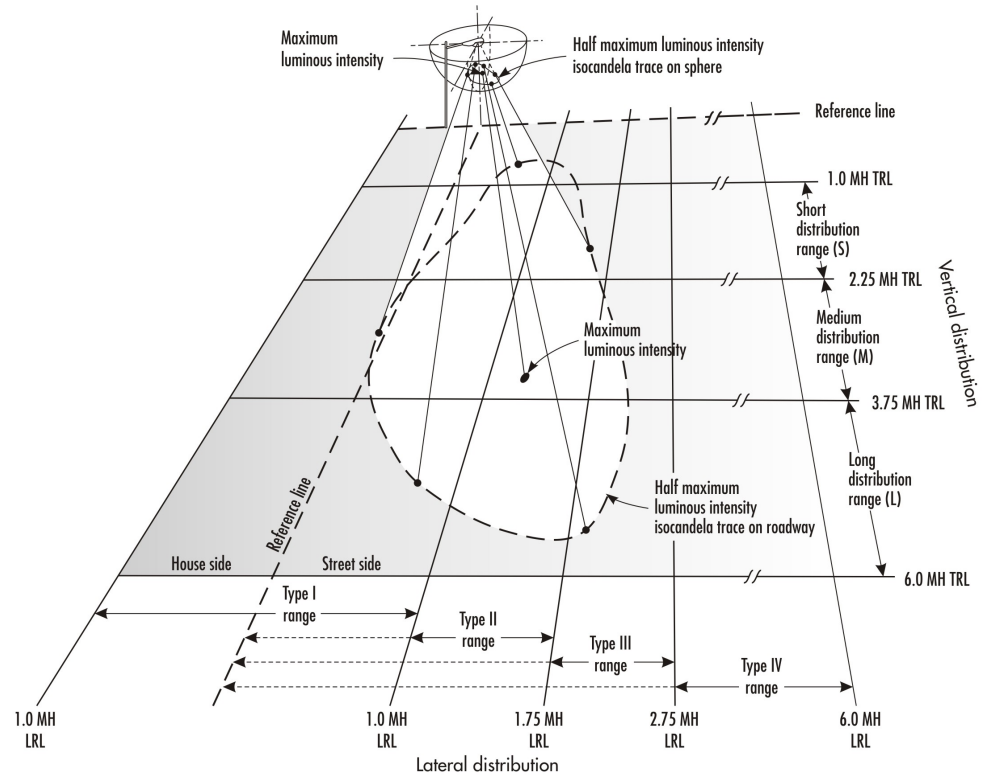

Figure 2. Diagram showing vertical and lateral IESNA distributions (NLP/IP 2004; adapted from Fig. 22-7 in *IESNA Lighting Handbook*, 9th Edition [Rea 2000]).

As may be inferred from Figure 2, the lit areas under different types of luminaires have different shapes and coverage. For example, Type III lateral distribution throws light farther across the road than Type II, which means it may light a wider road than Type II. A Medium vertical distribution covers farther along the length of the road than a Short distribution, which means the pole spacing can be greater. The luminaire shown in Figure 2 has a Type III Medium distribution.

The size of the lit area for roadway lighting luminaires is measured by the mounting height (MH) of the luminaire, sometimes called pole height, using Longitudinal Roadway Lines (LRL) for lateral distributions and Transverse Roadway Lines (TRL) for vertical distributions. The boundaries for lateral and vertical distributions are shown in Figure 2.

Traditional Metrics

Evaluating the energy efficiency of a lighting application primarily has been based on the efficacies of the light source and the luminaire system. Most activities to improve the energy efficiency of lighting have been directed toward reducing power demand (Rea and Bullough 2001). Lamp efficacy—the number of lumens emitted per watt of power used by a given lamp—is not necessarily the same as luminaire system efficacy because other components (e.g., ballast or driver, optics, housing, etc.) may increase power usage or decrease the number of lumens exiting the luminaire.

Luminaire system efficacy (in lumens per watt) is typically considered the best way to evaluate the efficacy of a luminaire. It is calculated as the light output (in

lumens) from the luminaire divided by the system input power (in watts), as shown below:

Luminaire System Efficacy (LSE)
= Luminaire Light Output (Φ) \div Luminaire System Power (P)

Or, simply:

$$\text{LSE} = \Phi \div P \quad (1)$$

As we can see from equation 1, luminaire system efficacy can improve by increasing the light output from the luminaire or by reducing the system input power of the luminaire. Improvements are typically achieved by increasing the optical efficiency of the luminaire or increasing the luminous efficacy of the light source. The luminaire system efficacy metric is sufficient when comparing one luminaire against another of similar characteristics, but it may not be sufficient when evaluating luminaire performance in terms of how effectively it can deliver light to the task plane of the lighting application. Though luminaires generally are designed to emit light in a particular direction, luminaire system efficacy (and the corresponding luminaire efficacy rating) does not consider light distribution or how effectively a luminaire delivers light to a particular location, nor is there any obvious relationship between these two factors. Yet, these two factors are very important for an acceptable and efficient lighting application (Rea and Bullough 2001).

Another proposed metric, called *application efficacy*, is concerned with delivering light to where it is needed in the most energy-efficient manner and is defined as the average luminous flux within a specific solid angle per unit of power (Rea and Bullough 2001).

In the case of parking lot lighting, the task plane of the lighting application is the pavement surface. For instance, a parking lot luminaire should not be considered efficacious for the application if it delivers most of the light toward the sky instead of the pavement, even if the light output exiting the luminaire is high and the input system power is low, creating a highly efficacious luminaire under traditional metrics.

Proposed Alternative Metric

To address the issue of performance in a given application, a modified version of luminaire system efficacy is proposed here, called *Luminaire System Application Efficacy* (LSAE). The following sections explain the rationale behind this new metric.

Luminaire System Application Efficacy

This proposal includes only the light output that falls on the task plane, Φ_{task} , and that meets the photometric requirements of the task at hand. For example, in parking lot applications the main photometric requirements are specified in terms of minimum illuminance levels and maximum uniformity ratios (IESNA 1998).

As a first step, equation 2 shows a simplified LSAE that includes only the light falling inside the task plane.

$$\text{LSAE} = \Phi_{\text{task}} \div P \quad (2)$$

By not including the light output beyond the task plane in the equation, the luminaires that “waste” light by sending light outside the task plane are penalized, leading to a more “target-oriented” evaluation system that compares luminaires on their effectiveness of delivering light to the specific application. The following sections detail how the proposed LSAE is further refined to include the characteristics of the task plane, the light level and uniformity requirements, and the characteristics of the luminaire.

Defining the Task Plane

To determine the Luminaire System Application Efficacy in parking lot applications, the task plane needs to be defined as a function of the luminaire type used and the mounting height. The task plane should be different for different luminaire distribution types because they are intended for different target areas. Using a luminaire with a Type III Medium distribution as an example, the task plane can be defined as the rectangle enclosed by the maximum boundaries of the Type III lateral distribution and the Medium vertical distribution (see maximum boundaries noted in Figure 2). The maximum boundary of a Type III distribution is up to 2.75 times the mounting height (MH), and the maximum boundary of a Medium vertical distribution is up to $3.75 \times \text{MH}$ on both sides, creating a rectangle with a width of 2.75 MH and a length of $2 \times 3.75 \text{ MH} = 7.5 \text{ MH}$. Using a mounting height of 30 feet in this example, the width of the rectangle will be 82.5 ft. ($2.75 \times 30 \text{ ft.}$) and the length of the rectangle will be 225 ft. ($3.75 \times 2 \times 30 \text{ ft.}$), as shown in Figure 3.

The proposed task plane dimensions for luminaire Types I to V are listed in Tables 1 and 2 (see Evaluation Method below). It is worth emphasizing that luminaires Type I and Type V are designed to be used in or around the center of the area they illuminate, whereas luminaires Types II to IV are designed to be used near the edge of the area. For this reason, as shown in Table 3, the task area for luminaires Type I and Type V is such that both the forward and the backward light contributions are accounted for. Similarly, for Types II to IV, the task area is defined such that only the forward light is accounted for.

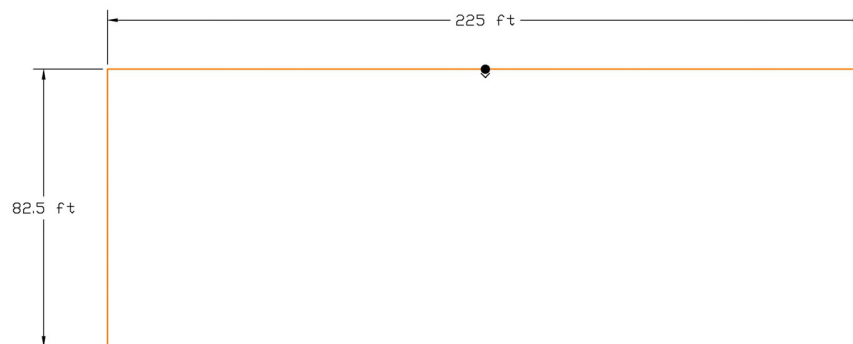

Figure 3. Task plane for a luminaire with a Type III Medium distribution at a 30 ft. mounting height. The location of the fixture is shown with a black dot and a chevron.

Range of Illuminance Values

Lighting for Parking Facilities RP-20-98 (IESNA 1998) recommends a maintained minimum horizontal illuminance level of 0.2 fc for “basic” parking lot lighting with a max-to-min uniformity ratio of 20:1 or less. Ideally, a perfectly uniform illuminance of 0.2 fc (for the “basic” level) is achieved and maintained

everywhere on the task plane, with a uniformity ratio of 1:1 (max-to-min). But this ideal condition is very difficult to achieve, and there is always a certain degree of non-uniformity. Since RP-20-98 recommends a uniformity ratio of at most 20:1 (max-to-min), it is reasonable to consider all illuminance values above 4.0 fc to be wasteful. Therefore, an illuminance range of 0.2 fc to 4.0 fc can be defined as suitable for the task plane, and any illuminance values outside this range should be penalized. For the “enhanced security” level, the range given in RP-20-98 is 0.5 fc to 7.5 fc (max-to-min of 15:1).

The first step to determining whether the illuminance values in the task plane conform to the relevant illuminance range is to divide the task plane into a calculation grid with a number (N) of cells of a determined size. Research leading to this publication showed that for common luminaire types and mounting heights, the optimum cell size is 2.5 ft. by 2.5 ft. For the example, depicted in Figure 4, the calculation grid would have a total of N = 2970 cells, derived from dividing the width and length of the task plane by 2.5 ft. Thus, N = (82.5 ft. ÷ 2.5 ft.) × (225 ft. ÷ 2.5 ft.) = 33 cells × 90 cells = 2970 cells. Once the illuminance value at the center of each cell has been calculated, a determination can be made whether each cell is within the desired range (0.2 fc to 4.0 fc in this example).

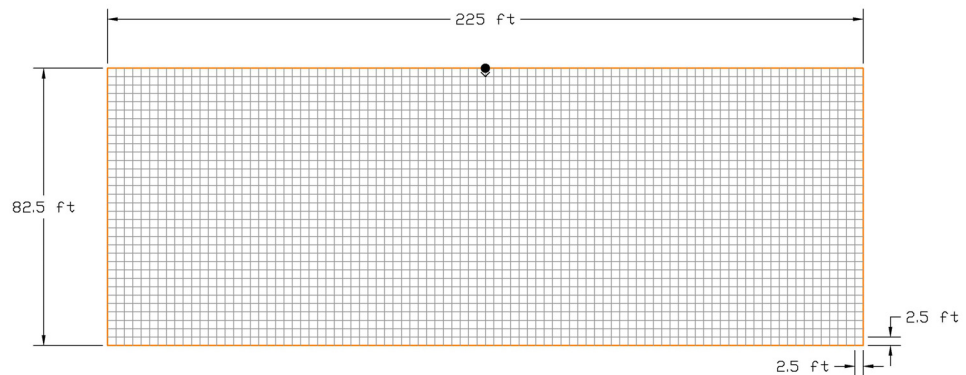

Figure 4. Calculation grid for the task plane for a luminaire with a Type III Medium distribution at a 30 ft. mounting height.

The purpose of the calculation grid is two-fold. First, it allows designers and planners to see the spread of light levels that a single luminaire would produce in the intended application and make observations about the uniformity. Second, it allows for estimation of the luminous flux falling within each cell of the grid by conducting a simple calculation based on the definition of illuminance, E, where E is equal to the luminous flux (Φ) divided by the area of incidence. Because the area of each grid cell ($Area_{cell} = 2.5 \text{ ft} \times 2.5 \text{ ft} = 6.25 \text{ ft}^2$) and the illuminance at the center of each grid cell (E_{cell}) are known, it is possible to estimate the luminous flux reaching each cell (Φ_{cell} ; equation 3).

$$\Phi_{cell} = E_{cell} \times Area_{cell} \quad (3)$$

Penalizing Non-conforming Cells

If any cell has an illuminance value within the desired illuminance range (0.2 fc to 4.0 fc in this example), then this cell is considered a conforming cell (equation 4); otherwise it is a non-conforming cell. If the total number of conforming cells is counted as $N_{conforming}$, then $N_{conforming} \div N$ is the ratio of the number of conforming

cells to the total number of cells within the task plane and can be interpreted as a percentage of coverage.

When evaluating the efficacy of a parking lot luminaire, the non-conforming cells should be penalized. Therefore, when calculating the luminous flux falling on the task plane, the non-conforming cells are not included. The total luminous flux falling on the task plane Φ_{task} is now modified to $\Phi_{\text{task-conforming}}$ (i.e., the sum of the luminous flux falling only on the conforming cells; equation 5).

$$\Phi_{\text{conforming-cell}} = E_{\text{conforming-cell}} \times \text{Area}_{\text{cell}} \quad (4)$$

$$\Phi_{\text{task-conforming}} = \sum_{i=1}^{N_{\text{conforming}}} \Phi_{\text{conforming-cell}_i} \quad (5)$$

Further, because the target should always be to have a high percentage of coverage while meeting the illuminance requirements for a given task plane size, the ratio $N_{\text{conforming}} \div N$ is incorporated in the formula to calculate LSAE, resulting in equation 6:

$$\text{LSAE} = (\Phi_{\text{task-conforming}} \times (N_{\text{conforming}} \div N)) \div P \quad (6)$$

where LSAE is the Luminaire System Application Efficacy for a given luminaire distribution type and mounting height; $\Phi_{\text{task-conforming}}$ is the luminous flux reaching only those grid cells that meet the photometric requirements of minimum illuminance and uniformity; $N_{\text{conforming}} \div N$ is the percentage of coverage; and P is the total input power to the luminaire in watts.

The New Metric

Equation 6 is used to calculate LSAE, the new metric proposed in this *ASSIST recommends* document for evaluating the efficacy of parking lot luminaires. The goal of this new metric is to promote luminaires that efficiently deliver the light output to the task plane while producing illuminance values that are in the appropriate range, and to provide as much coverage of the task plane as possible. The next section will provide a step-by-step method to evaluate a parking lot luminaire based on this new metric, with the help of commercially available lighting calculation software.

Extending the LSAE Metric to Defined Parking Lot Areas

The LSAE metric as described above applies to individual luminaires. However, if a particular parking lot geometry has been defined and a lighting layout is under examination, the same principle can be used to obtain the application efficacy of the complete system by simply adding up the luminous flux of conforming cells spread across the area making up the parking lot, factoring in the percentage of coverage, and dividing that figure by the total input power of the system (i.e., the sum of the input power of all luminaires included in the layout). In this way, the metric can be used for any parking lot geometry and any lighting layout, whether one or more luminaire types are included. Similarly, the LSAE principle can be applied to configurations with more than one luminaire per pole. The next section describes the evaluation method for cases with a single luminaire per pole. See *Extension to Multiple Poles, Luminaires and Application Configurations* on page 19 for details on how to evaluate configurations with two or four luminaires, as well as extending to an entire application area.

Evaluation Method

Luminaire System Application Efficacy (LSAE)

Generally speaking, the evaluation process for LSAE includes three major steps. The first step is to obtain an accurate measurement of the intensity distribution of the luminaire. The second step is to calculate the illuminance values on the task plane. The third step is to calculate the LSAE based on the illuminance values and the input power of the system.

Step 1: Obtain the intensity distribution of the luminaire under evaluation

It is important that the intensity distribution data of the luminaire under evaluation be representative of the luminaires to be used in practice. Because of the expense and time involved in testing, it is possible that some of the photometric reports available for commercial luminaires have not been updated to reflect changes in the manufacturing process of the luminaires over time, production tolerances, changes in materials, or any other changes that may result in a significantly different intensity distribution. Previous LRC studies have shown significant differences between the information provided with the luminaire and the performance measured by a third-party laboratory (NLRIP 2004). If in doubt, a representative sample should be procured and tested.

Intensity distribution data is widely available in electronic format (e.g., an IES-LM-63 fileⁱ [IESNA 2002]) for ease of data communication and manipulation in computing software. It is important to verify that the electronic file contains the luminaire input power at the time of photometric testing and clear instructions about whether adjusting factors need to be applied, such as a ballast factor, a lumen multiplier for different lamp types, etc.

Step 2: Calculate the illuminance values on the task plane

This step can be completed using any commercially available calculation software. In the steps below, the graphics and illuminance calculations were generated using AGi32ⁱⁱ, version 2.0. Several intermediate steps are needed to set up the calculation area and the luminaire information.

Step 2.1: Set up the extension of the testing area

Create a flat rectangular area in the calculation software that is large enough to contain the task plane. In this example, the area is 400 ft. by 300 ft. in the X and Y directions as shown in Figure 5.

ⁱ IES-LM-63 formatted files (.IES) are widely used and available in the lighting industry, but other formats are available as well, including CIBSE TM-14 files (CIBSE 1988), CIE 102 files (CIE 1993) and EULUMDAT files (.ltd; Stockmar 1990, 1998).

ⁱⁱ Lighting Analysts, 10440 Bradford Road, Unit A, Littleton, Colorado USA 80127 Tel. 303-972-8852, www.agi32.com.

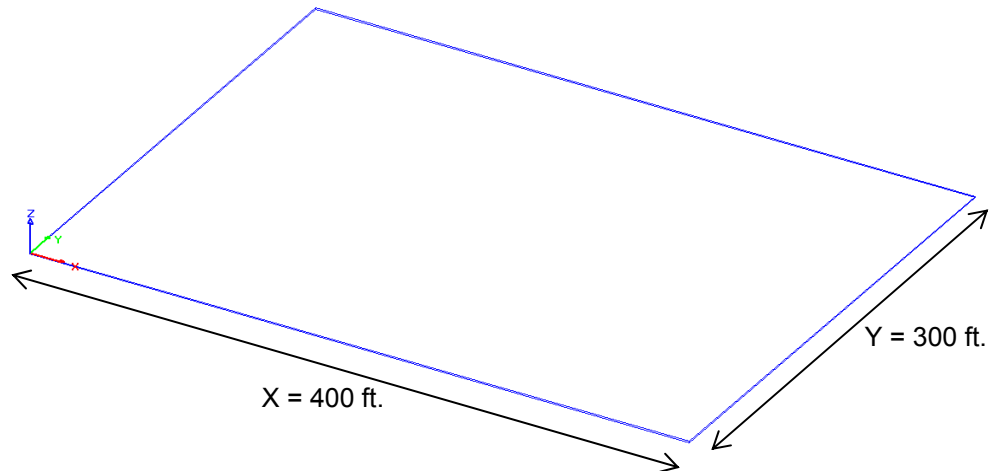

Figure 5. Testing area that will contain the calculation grid corresponding to the task plane defined by the luminaire distribution and mounting height.

Step 2.2: Add the luminaire to the testing area

First, determine a mounting height for the luminaire being evaluated (typically between 15 and 45 feet for commercial parking lots).ⁱⁱⁱ In the steps below, a mounting height of 30 feet will be used as an example. Second, define the luminaire using the intensity distribution data file obtained in Step 1 and locate it at the center of the testing area at the specified mounting height (Figure 6). The characteristics of the pole can be ignored in this method because the pole should not be included in the photometric calculations.

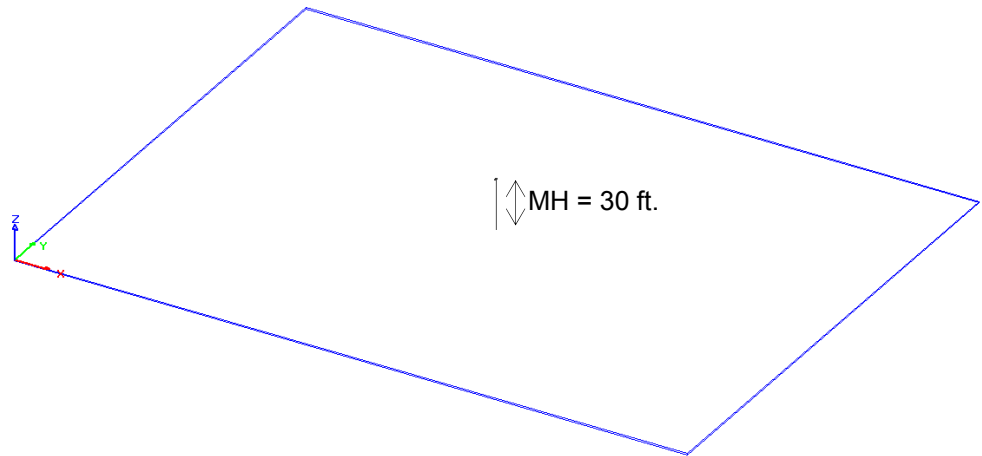

Figure 6. Luminaire located at the center of the testing area at a determined mounting height (MH = 30 ft. in this example).

ⁱⁱⁱ The LSAE value calculated is specific to the mounting height. Different values can be expected for the same luminaire at different mounting heights because the definition of the task plane, as well as the light levels and coverage produced by the luminaire, would change accordingly. Thus, for a given luminaire configuration (i.e., the optics selection and the light output of the source), it is possible to find an optimum mounting height. The selection of a mounting height has trade-offs, however. The mounting height can be optimized to provide either a) the best LSAE value while meeting the illuminance criteria, or b) the largest coverage area, resulting in greater pole spacing and fewer poles, while meeting the illuminance criteria. Those two conditions may not always happen at the same time; thus, if a larger coverage area per pole is desired, the higher mounting height may result in a lower LSAE value than a mounting height optimized for LSAE.

Step 2.3: Define the task plane

First, determine the photometric distribution type of the luminaire (i.e., its vertical and lateral light distribution classifications). The luminaire classification type should be included in the catalog information from the manufacturer. If the luminaire classification type is not specified by the manufacturer, it can be determined by using the photometric analysis tools included in most calculation software programs.

Second, create a rectangular illuminance calculation grid of X by Y dimensions with 2.5 ft. by 2.5 ft. grid spacing. Tables 1 and 2 show the proposed values of X and Y for different types of photometric distributions when a single luminaire per pole is being evaluated. The calculation grid will contain $N = (X \div 2.5 \text{ ft.}) \times (Y \div 2.5 \text{ ft.})$ square cells, with one illuminance calculation point at the center of each cell.

See *Extension to Multiple Poles, Luminaires and Application Configurations* on page 19 for evaluation of multiple luminaires per pole.

Table 1. Proposed Y and X dimensions of the task plane for a single luminaire (location shown with black dot), based on the lateral and vertical distribution types of the luminaire and the mounting height (MH).

Lateral Distribution Type	Y dimension
Type I	2.00 x MH
Type II	1.75 x MH
Type III	2.75 x MH
Type IV ^{iv}	6.00 x MH
Type V ^v	Same as X dimension

Vertical Distribution Type	X dimension
Very Short ^{vi}	2.00 x MH
Short	4.50 x MH
Medium	7.50 x MH
Long	12.00 x MH

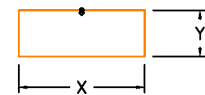

^{iv} The IESNA does not define an upper boundary for Type IV classifications. For the purpose of this method, an upper boundary of 6 x MH is proposed (NLPIP 2004).

^v No vertical or lateral distribution definition exists for Type V luminaires; therefore, for the purpose of this method a square area based on the dimension corresponding to the vertical distribution type is proposed.

^{vi} While not a standard IESNA vertical light distribution classification, manufacturers of street and area lighting luminaires use the term *very short* for luminaires that have a maximum intensity point that falls between the reference line and the 1 x MH transverse roadway line (Figure 2; Rea 2000, NLPIP 2004).

Table 2. Schematic of proposed dimensions of the task plane for a single luminaire, based on the lateral and vertical distribution types of the luminaire (location shown with black dot) and the mounting height (MH).

	Type I	Type II	Type III	Type IV	Type V
Very Short					
Short					
Medium					
Long					

Figure 7 shows the resulting task plane and calculation grid for this example using a Type III Medium luminaire at a 30 ft. mounting height. The task plane dimensions are 225 ft. by 82.5 ft. and the calculation grid contains a total of 2970 points.

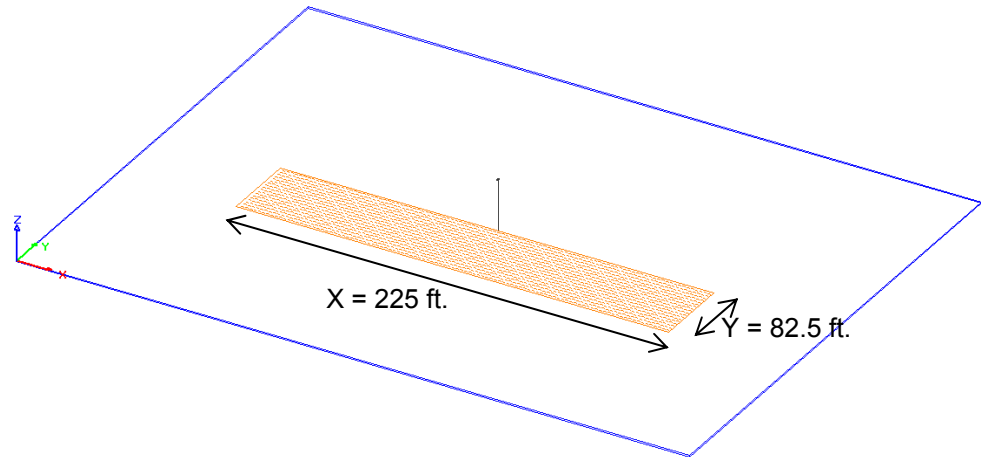

Figure 7. Dimensions of the task plane and calculation grid for a Type III medium luminaire at a mounting height of 30 ft.

Step 2.4: Perform illuminance calculations

Note: It is worthwhile emphasizing that before running illuminance calculations, all the necessary depreciation factors should be included in the calculation setup. The IESNA illuminance recommendations are for maintained values; that is, after considering the light loss factors that can be anticipated in any design and that would ensure that at any given point in time the lighting system will provide at least the minimum required. Different sources provide guidance on how to estimate recoverable and non-recoverable light loss factors for outdoor systems. See for instance the *IESNA Lighting Handbook*, 9th Edition (Rea 2000).

Perform the photometric calculations in the software and obtain the horizontal illuminance values in each cell of the grid. The illuminance value is measured at the center of the 2.5 × 2.5 ft. square cell.

One of the benefits of using commercial software is that additional information can be obtained, such as the iso-illuminance lines shown in Figure 8.

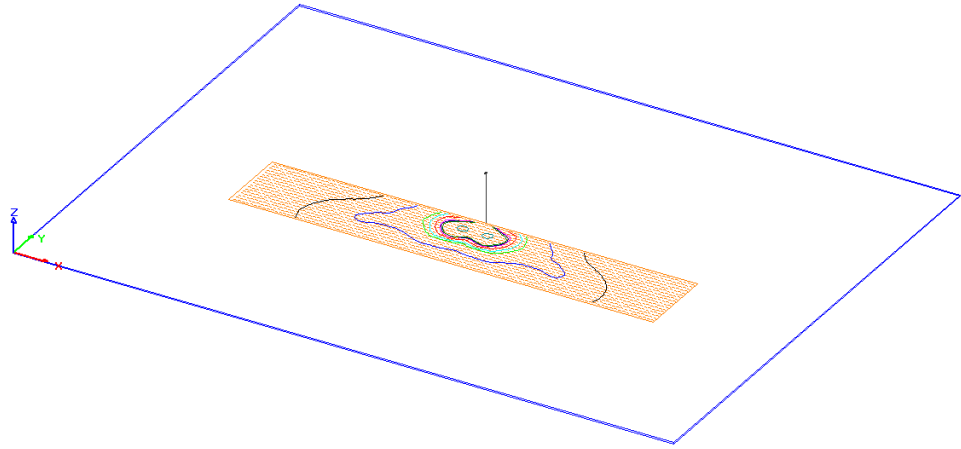

Figure 8. Resulting iso-illuminance lines from the calculations performed in AGI32.

Step 3: Calculate LSAE

This step involves manipulating the illuminance calculations obtained in the previous step and can be more easily completed with the aid of spreadsheet software. In this example, the illuminance calculation values were exported to a Microsoft Excel spreadsheet where simple arithmetic computations are easily accomplished.

Step 3.1: Find the conforming cells

For each of the N cells in the grid, check if the illuminance value is within the range of 0.2 fc 4.0 fc (or between 0.5 fc and 7.5 fc for enhanced security applications). If yes, that cell is a conforming cell. Count the number of conforming cells ($N_{conforming}$) and calculate the percentage of coverage as the ratio $N_{conforming} \div N$.

Step 3.2: Calculate the luminous flux reaching conforming cells ($\Phi_{conforming-cell}$)

The luminous flux reaching each conforming cell can be estimated using equation 4, where E is the illuminance at the center of the conforming cell and Area equals 6.25 ft² (2.5 ft. × 2.5 ft. = 6.25 ft²).

$$\Phi_{conforming-cell} = E_{conforming-cell} \times Area_{cell} \tag{4}$$

Step 3.3: Calculate the useful luminous flux reaching the task plane ($\Phi_{task-conforming}$)

The useful luminous flux on the task plane is calculated by adding up the luminous flux of each one of the conforming cells (i.e., only those cells that are within the illuminance range of interest).

$$\Phi_{task-conforming} = \sum_{i=1}^{N_{conforming}} \Phi_{conforming-cell_i} \tag{5}$$

Step 3.4: Calculate LSAE

The final step to calculate LSAE is to apply the percentage of coverage ($N_{conforming} \div N$) to the useful luminous flux on the task plane ($\Phi_{task-conforming}$) and divide by the total input power to the luminaire (P), as shown in equation 6.

$$\text{LSAE} = [\Phi_{\text{task-conforming}} \times (N_{\text{conforming}} \div N)] \div P \quad (6)$$

The appendix shows a sample report form that can be used to report the LSAE values for a luminaire.

CCT, CRI, and Chromaticity

For traditional technologies (i.e. HID, fluorescent and incandescent), it is common practice to report the lamp CCT, CRI, and CIE x,y values as provided by the lamp manufacturer or testing laboratory. For LED luminaires, the IES LM-79-08 standard calls for testing the photometric and colorimetric properties of the complete luminaire (IESNA 2008).

Glare and Uplight

Light radiating at high vertical angles (approximately 75° to 80°) from a parking lot luminaire can potentially cause glare, although in many situations it is possible to create glare from light at lower angles (e.g., 60°). Glare is a critical issue in parking lot luminaire design, due to the high luminous intensity required for illuminating a large area at night. Designers may need to look at the luminous flux exiting a luminaire at a certain angle (the *glare zone*), the luminaire mounting height, and visually adjacent luminaires to evaluate the potential for glare in a particular situation (NLPIP 2004, 2007). Also, the uplight content (light that extends to angles greater than 90°) from the luminaire can be considered a waste of light and can contribute to glare and light pollution. More information can be obtained from the IESNA's *TM-15-07 Luminaire Classification System for Outdoor Luminaires* (IESNA 2007a) and the companion document *Addendum A for IESNA TM-15-07* (IESNA 2007b).

This document does not directly address glare and light pollution because those issues are contextual; thus, specific information about the application in which the luminaire is used is needed. Additional information and evaluation tools can be found in two methods of predicting light pollution and glare from outdoor lighting installations that the Lighting Research Center has published. The first is a comprehensive method for predicting and measuring the three aspects of light pollution, called the Outdoor Site-Lighting Performance method (Brons et al. 2008). The second is a simple, quantitative model to predict discomfort glare from outdoor lighting installations (Bullough et al. 2008).

Mesopic Characterization of Outdoor Lighting

Recent research into how the eye “sees” under mesopic conditions and the development of an alternative, unified system of photometry support the possible trade-off between light source spectrum and light level for light sources used in nighttime, outdoor applications (Rea et al. 2004). ASSIST has published step-by-step instructions for calculating the *unified luminance* of a given light source based on light level and the scotopic-to-photopic ratio of the light source. Different combinations of light sources and light levels may produce the same unified luminance, which indicates photometric equivalency. Therefore, the system can serve as a simple method for trading off light sources and light levels under mesopic conditions, and thereby aid in the selection of light sources for a given application. For more information, see *ASSIST recommends...Outdoor Lighting: Visual Efficacy* (ASSIST 2009) and IESNA's TM-12-06, *Spectral Effects of Lighting on Visual Performance at Mesopic Light Levels* (IESNA 2006).

Extension to Multiple Poles, Luminaires and Application Configurations

The metric as described above is designed to compare one luminaire against another in terms of one pole and one luminaire per pole within a defined task area. However, the metric can be extended to multiple poles, multiple luminaires per pole, and an entire application (parking lot) area. Extending the LSAE methodology to applications with multiple luminaires per pole simply requires re-defining the task area. This change in task area definition is especially needed for luminaire Types II, III and IV because under single luminaire conditions, the backlight is not accounted for. When two luminaires are installed back to back, the backlight of each luminaire contributes to the forward illumination of the other one.

Tables 3 and 4 show the proposed task areas based on the number of luminaires per pole, the lateral and vertical distribution types of the luminaires, and the mounting height (MH).

Table 3. Schematic of proposed dimensions of the task plane for poles with two luminaires, based on the lateral and vertical distribution types of the luminaire (location shown with black dot) and the mounting height (MH).

	Type I	Type II	Type III	Type IV	Type V
Very Short					
Short					
Medium					
Long					

Table 4. Schematic of proposed dimensions of the task plane for poles with four luminaires, based on the lateral and vertical distribution types of the luminaire (location shown with black dot) and the mounting height (MH). Note: Some combinations of vertical and lateral distribution for four-luminaire configurations may not be desirable in practice because they may require non-uniform positioning of luminaires or poles to meet parking lot lighting criteria.

	Type I	Type II	Type III	Type IV	Type V
Very Short					
Short					
Medium					
Long					

Table 5 and Figure 9 show the results from an analysis of the LSAE metric for different application configurations: one luminaire per pole, two luminaires per pole, four luminaires per pole, and the entire parking lot with multiple poles (with four luminaires of the same type per pole). The analysis was completed using three nominally 150W Type III Short luminaires with different light source technologies: high-pressure sodium (HPS), LED, and metal halide (MH). The luminaire arm length was set to zero. For two luminaires per pole, the two luminaires were placed back to back (180° from each other), with zero distance between them. For four luminaires per pole, the four luminaires were placed at 90° angles, again with zero distance between them. For the parking lot, the poles with four luminaires per pole were arranged to just meet the minimum illuminance and uniformity requirements. The analysis was performed using manufacturer-supplied .IES files of these three luminaires.

First, the LSAE for each luminaire at each configuration was calculated at different pole heights from 15 ft. to 60 ft. in 5-foot increments to find the maximum LSAE. Then the pole height, the LSAE, and the estimated application area size with the highest LSAE were recorded. Next, the estimated application area (260 ft. × 260 ft.) for the four luminaires per pole for HPS was used to create a parking lot area that was 15 times larger and composed of 5×3 sub-areas of 260 ft. by 260 ft. each (i.e., a rectangular area of 1300 ft. × 780 ft.). The pole height achieving the highest LSAE for the four HPS luminaires per pole was selected (40 ft.), and 15 poles were placed in this 1300 ft. by 780 ft. rectangular area, one pole at the center of each 260 ft. by 260 ft. sub-area. Finally, the three luminaires were compared in this fixed parking lot area with fixed pole placements. In the case of the LED and MH luminaires, the mounting height and pole spacing were kept the same as that of the HPS base case (i.e., a retrofit scenario).

The results show that the LSAE value for a single luminaire can predict the performance for the entire parking lot application compared with other luminaires, as well as for different luminaire configurations, because the LSAE order of magnitude stays the same for all three luminaire types: HPS > LED > MH. Thus, LSAE allows one to rank order the luminaires under consideration for an entire parking lot application. However, this finding is provided that all luminaires in comparison are of the same vertical and lateral distribution type.

Table 5. Analysis comparing LSAE values for multiple luminaire configurations and a complete parking lot application for three nominally 150 W Type III Short luminaires with three different light source technologies.

Lamp Type	<u>1 luminaire per pole</u>			<u>2 luminaires per pole</u>			<u>4 luminaires per pole</u>			LSAE in Parking Lot with 40 ft pole height (lm/W)
	Optimum Pole Height (ft)	LSAE at Optimum Pole Height (lm/W)	Estimated Area Dimension (ft)	Optimum Pole Height (ft)	LSAE at Optimum Pole Height (lm/W)	Estimated Area Dimension (ft)	Optimum Pole Height (ft)	LSAE at Optimum Pole Height (lm/W)	Estimated Area Dimension (ft)	
HPS	25	30.2	165 x 90	30	42.8	210 x 140	40	51.3	260 x 260	44.6
LED	20	25.6	140 x 70	30	40.5	195 x 145	40	44.9	245 x 245	34.9
MH	25	19.0	165 x 100	35	31.6	235 x 155	40	36.4	260 x 260	30.2

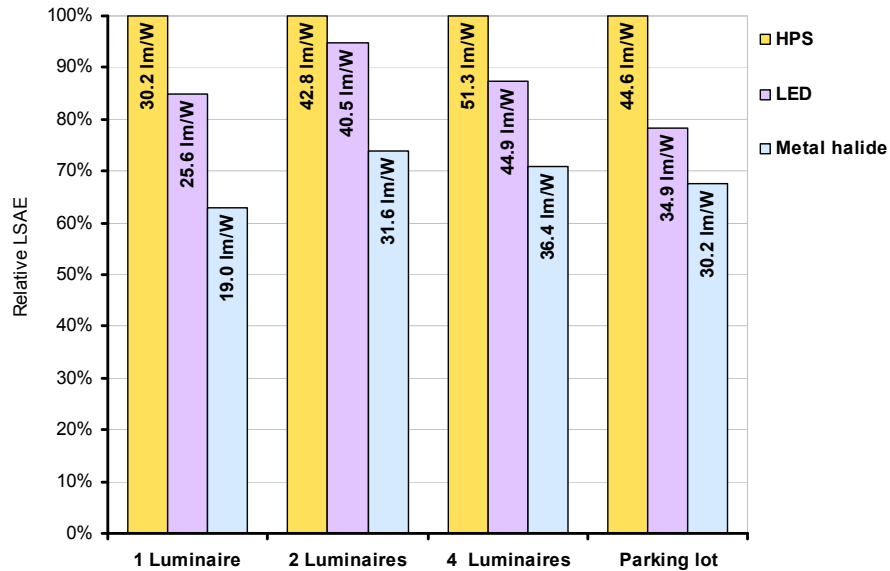

Fig. 9. Relative LSAE of three luminaires for one luminaire per pole, two luminaires per pole, four luminaires per pole, and multiple poles with four luminaires each in a parking lot. While the LSAE value changes as a function of the number of luminaires and poles, the rank order of each luminaire remains the same when comparing luminaires of the same lateral and vertical distributions.

Correlating LSAE to Energy Usage

LSAE can accurately predict energy use and the ability of a luminaire to meet IESNA recommendations for an application. Table 6 and Figure 10 show a comparison among six commercially available luminaires. In this analysis, LSAE values were calculated and the optimum mounting height for each luminaire determined. The number of luminaires necessary to illuminate a 600 ft. by 400 ft. parking lot was then calculated using commercial software. The criteria corresponded to IESNA RP-20-98 illuminance and uniformity requirements, and the configuration in all cases was two luminaires per pole at the optimum mounting height determined. Table 6 summarizes the characteristics of the luminaires and the results, including average illuminance, total number of luminaires, total input power, and lighting power density. Figure 10 shows lighting power density (W/ft^2) as a function of the LSAE value for the six luminaires. The LSAE values plotted show a correlation between higher efficacy and lower lighting power density, meaning that within a specific application, it is possible to compare and rank order luminaires.

Table 6. LSAE for six commercially available outdoor luminaires.

Sample	IESNA classification ⁱ	Mounting height ⁱⁱ	LSAE ⁱⁱⁱ	Number of luminaires ^{iv}	Average illuminance	Max:min ratio	Total input power (W)	Lighting power density (W/ft ²)
A	III very short	40 ft	31 lm/W	30	1.16 fc	13	5640	0.0235
B	III short	30 ft	41 lm/W	32	1.28 fc	13	4672	0.0195
C	III medium	30 ft	18 lm/W	40	1.68 fc	20	7320	0.0305
D	III medium	30 ft	22 lm/W	32	1.28 fc	15	6048	0.0252
E	III medium	30 ft	28 lm/W	32	1.44 fc	20	5920	0.0247
F	II medium	35 ft	30 lm/W	32	1.34 fc	10	5280	0.0220

ⁱ Determined from the IES file of the luminaires sampled

ⁱⁱ Optimum mounting height is determined as the height of maximal LSAE

ⁱⁱⁱ Online calculator available at <http://www.lrc.rpi.edu/parkinglot>

^{iv} Total number of luminaires needed to meet IES RP-20-98 criteria of minimum 0.2 fc and 20:1 max:min ratio for the predetermined area, as determined using AGi32 software.

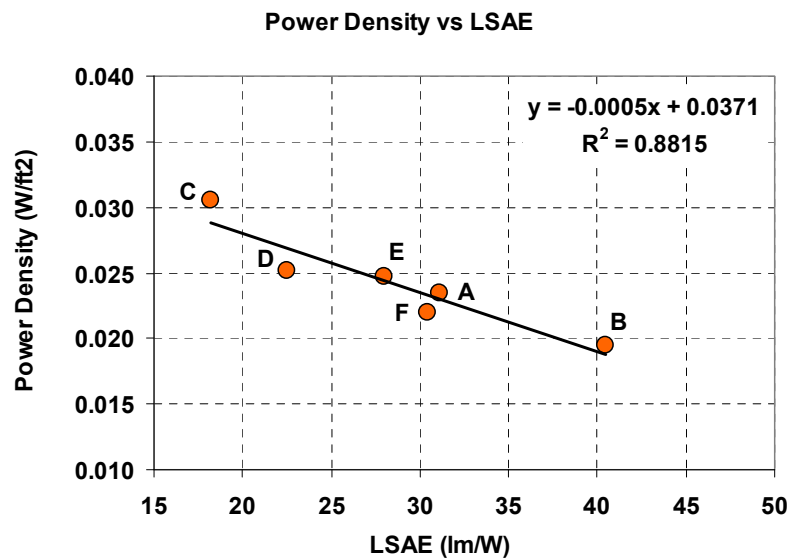

Fig. 10. Power density of a 600 ft. by 400 ft. parking lot as a function of LSAE.

Summary

Luminaire System Application Efficacy measures luminaire efficacy when it meets recommended IESNA criteria for both absolute minimum illuminance and illuminance uniformity ratios at a given mounting height and for an area determined according to the luminaire’s IESNA lateral and vertical classification. It can be used for single luminaires, multiple configurations, or by extension to a complete installation.

LSAE is a technology-neutral, application-specific metric that can be adapted to multiple applications (e.g., roadway lighting) by simply changing the lighting criteria following IESNA or other standard recommendations. For example, LSAE

can be calculated using parking lot recommendations for basic illumination or enhanced security, or any type of roadway lighting criteria, so that end users can compare across products under the same conditions. These criteria adjustments are reflected in luminaire performance changes.

LSAE provides a number that is specific to the mounting height, optical characteristics, and light output of a given luminaire such that designers can determine the conditions under which the luminaire will perform best at meeting illuminance and uniformity criteria. LSAE values for a given luminaire change depending on the application. A higher rating on LSAE metric will ensure the application has appropriate light levels to meet the application's need.

Additionally, LSAE allows a designer to find the optimum mounting height to meet the IESNA recommended criteria while maximizing the coverage area (and spacing between poles). With this information, a designer can choose the best luminaire for the given application or rank order a number of products.

Online Calculator

A free online tool is available for calculating LSAE for commercial parking lot luminaires: <http://www.lrc.rpi.edu/parkinglot>.

References

- Alliance for Solid-State Illumination Systems and Technologies (ASSIST). 2009. *ASSIST recommends...Outdoor Lighting: Visual Efficacy*. Volume 6, Issue 2. Troy, N.Y.: Lighting Research Center. Internet: <http://www.rpi.edu/programs/solidstate/assist/recommends/outdoorlighting.asp>.
- Brons, J.A., J.D. Bullough, and M.S. Rea. 2008. Outdoor site-lighting performance: A comprehensive and quantitative framework for assessing light pollution. *Lighting Research and Technology* 40(3): 201–224.
- Bullough, J.D., J.A. Brons, R. Qi, and M.S. Rea. 2008. Predicting discomfort glare from outdoor lighting installations. *Lighting Research and Technology* 40(3): 225–242.
- Chartered Institution of Building Services Engineers (CIBSE). 1988. *Standard File Format for Transfer of Luminaire Photometric Data*. TM14. London: CIBSE.
- Commission Internationale de l'Éclairage (CIE). 1993. *Recommended File Format for Electronic Transfer of Luminaire Photometric Data*. CIE 102-1993. Vienna: CIE.
- Illuminating Engineering Society of North America (IESNA). 1998. *Lighting for Parking Facilities*. RP-20-98. New York: IESNA.
- Illuminating Engineering Society of North America (IESNA). 2002. *Standard File Format for Electronic Transfer of Photometric Data and Related Information*. LM-63-02. New York: IESNA.
- Illuminating Engineering Society of North America (IESNA). 2006. *Spectral Effects of Lighting on Visual Performance at Mesopic Light Levels*. TM-12-06. New York: IESNA.
- Illuminating Engineering Society of North America (IESNA). 2007a. *IES TM-15-07 Luminaire Classification System for Outdoor Luminaires*. New York: IESNA.
- Illuminating Engineering Society of North America (IESNA). 2007b. *Addendum A for IESNA TM-15-07: Backlight, Uplight and Glare (BUG) Ratings*. New York: IESNA. Internet: <http://www.ies.org/PDF/Erratas/TM-15-07BUGRatingsAddendum.pdf>.
- Illuminating Engineering Society of North America (IESNA). 2008. *Approved Method: Electrical and Photometric Measurements of Solid-State Lighting Products*. LM-79-08. New York: IESNA.
- National Lighting Product Information Program (NLPIP). 2004. *Specifier Reports: Parking Lot and Area Luminaires*. Troy, N.Y.: Lighting Research Center. Internet: <http://www.lrc.rpi.edu/nlpip/publicationDetails.asp?id=900&type=1>.
- National Lighting Product Information Program (NLPIP). 2007. *Lighting Answers: Light Pollution*. Troy, N.Y.: Lighting Research Center. Internet: <http://www.lrc.rpi.edu/nlpip/publicationDetails.asp?id=884&type=2>.
- Rea, M.S. (ed.). 2000. *IESNA Lighting Handbook: Reference and Application*, 9th Edition. New York: Illuminating Engineering Society of North America.
- Rea, M.S. and J.D. Bullough. 2001. Application efficacy. *Journal of the Illuminating Engineering Society* 30(2): 73–96.

- Rea, M.S., J.D. Bullough, J.P. Freyssinier-Nova, and A. Bierman. 2004. A proposed unified system of photometry. *Lighting Research and Technology* 36(2): 85-111.
- Stockmar, A. 1990. EULUMDAT—ein Leuchten-Datenformat für den europäischen Beleuchtungsplaner, *Tagungsband Licht* 90: 641–644.
- Stockmar, A.W. 1998. Eulumdat 2: an extended version of a well-established luminaire data format. *Proceedings of the CIBSE National Lighting Conference*, Lancaster University, 5-8 April, 1998.

Acknowledgments

ASSIST and the Lighting Research Center would like to thank the following for their review and feedback during the development of this publication: Acuity Brands Lighting, Beta LED/Ruud Lighting, Cree, GE Lumination, HADCO/Genlyte, Lighting Science Group, Lumec, OSRAM Opto Semiconductors, and Philips Color Kinetics; Russ Leslie and Leora Radetsky of the Lighting Research Center for their valuable input and review; Dan Wang and Oindrila Hazra of the Lighting Research Center for their assistance with data collection.

About ASSIST

ASSIST was established in 2002 by the Lighting Research Center at Rensselaer Polytechnic Institute to advance the effective use of energy-efficient solid-state lighting and speed its market acceptance. ASSIST's goal is to identify and reduce major technical hurdles and help LED technology gain widespread use in lighting applications that can benefit from this rapidly advancing light source.

Appendix: Sample Calculation and Report Form

Sample Calculation

Step 1: Obtain the intensity distribution of the luminaire under evaluation

The IES file of a 150-watt HPS luminaire was obtained from the luminaire company's Web site. The manufacturer claimed this luminaire to have a Type III Medium distribution with a measured input power of 183 watts.

Step 2: Calculate the illuminance values on the task plane

For the example, the mounting height has been determined to be 30 feet.

Step 2.1: Set up the extension of the testing area

For this example, the testing area was set at 400 ft × 300 ft.

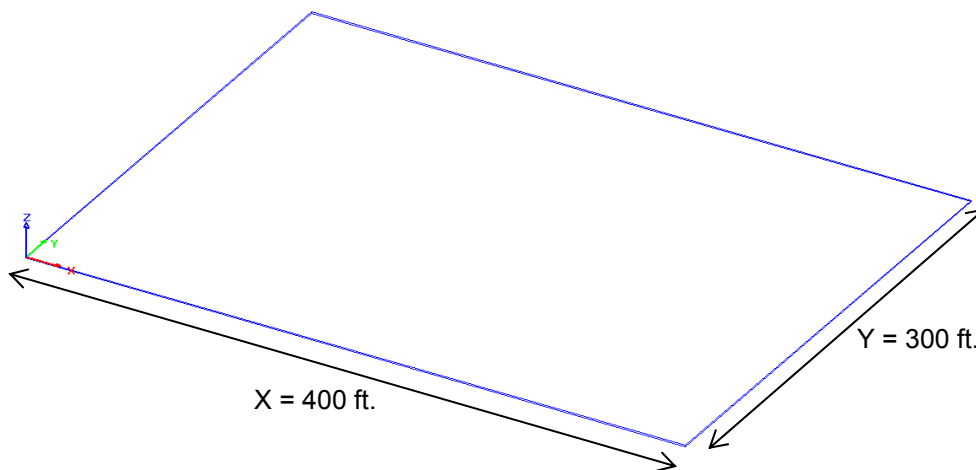

Step 2.2: Add the luminaire to the testing area

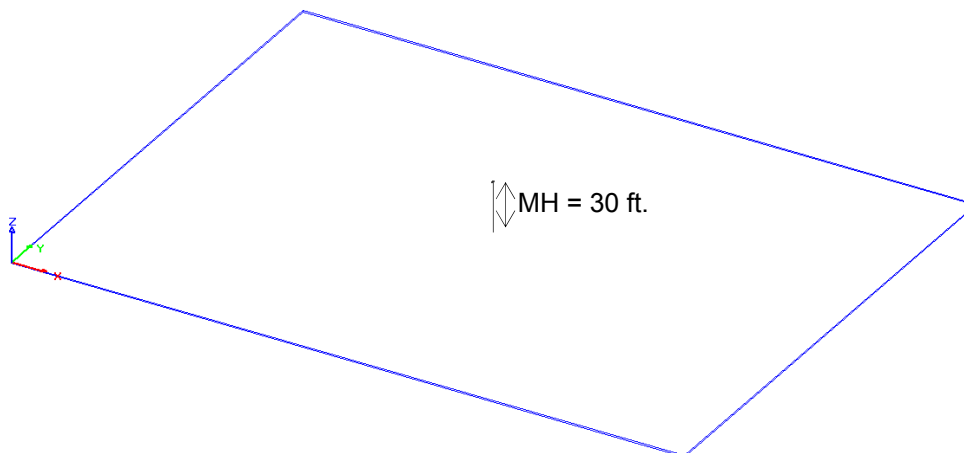

Step 2.3: Define the task plane

According to Tables 1 and 2, the dimensions of the task plane are $X = 7.5 \times 30 \text{ ft.} = 225 \text{ ft.}$ and $Y = 2.75 \times 30 \text{ ft.} = 82.5 \text{ ft.}$ Assign an illuminance grid of 2.5 ft. × 2.5 ft. spacing to this task plane.

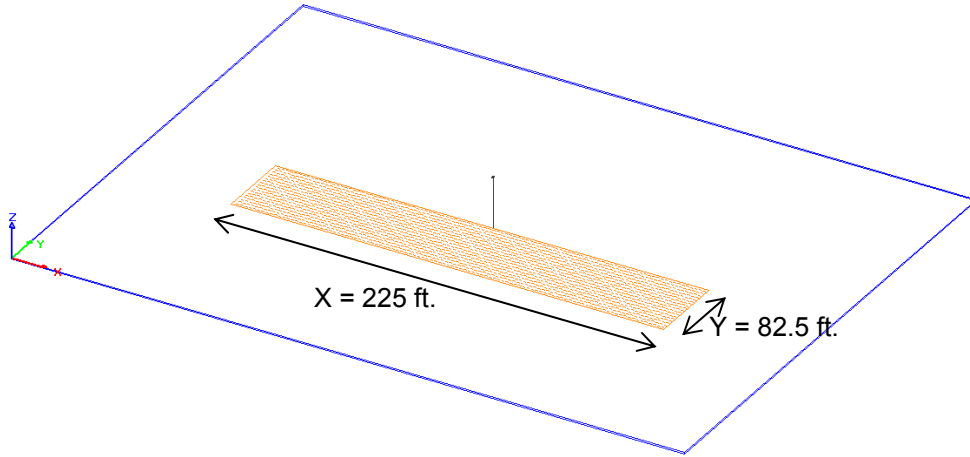

Step 2.4: Perform illuminance calculations

The illuminance values at the centers of all grid cells are then calculated.

Step 3: Calculate LSAE

Step 3.1: Find the conforming cells

Evaluate illuminance values at each point, and count the number of conforming cells (those with illuminance values of between 0.2 and 4 fc). For this example, the number of conforming cells equals 1396.

Step 3.2: Calculate the luminous flux reaching conforming cells ($\Phi_{\text{conforming-cell}}$)

To calculate the luminous flux on each conforming cell it is necessary to multiply the area of the cell times its illuminance. Each cell has an area of 2.5 ft. \times 2.5 ft. = 6.25 ft². For example, take a cell with an illuminance of 2.0 fc; the luminous flux in this cell will be 2.0 fc \times 6.25 ft² = 12.5 lm. This procedure is repeated for each conforming cell in the target task area. Suitable adjusting factors may need to be applied if the illuminance calculations are performed in units of lux (lx) or the layouts are set up in metric units.

Step 3.3: Calculate the useful luminous flux reaching the task plane ($\Phi_{\text{task-conforming}}$)

Finally, sum up the total luminous flux falling on all the conforming cells; in this example the total equals 6757 lm.

Step 3.4: Calculate LSAE

The general expression for LSAE is given by:

$$\text{LSAE} = (\Phi_{\text{task-conforming}} \times (N_{\text{conforming}} \div N)) \div P$$

where

$$N \text{ (total number of cells in the task plane)} = (225 \div 2.5) \times (82.5 \div 2.5) = 90 \times 33 = 2970$$

$$N_{\text{conforming}} = 1396$$

$$\Phi_{\text{task-conforming}} = 6757 \text{ lm}$$

$$P = 183 \text{ watts}$$

Therefore, in this example, the LSAE value is:

$$\text{LSAE} = (6757 \text{ lm} \times (1396 \div 2970)) \div 183 \text{ watts}$$

$$\text{LSAE} = 17.4 \text{ lm/W}$$

Sample Report Form

Following is the recommended minimum information to be included when reporting LSAE values of parking lot luminaires.

Product Information

Manufacturer: _____
Model number: _____
Light source type: _____
Photometry type: _____

Measured Data

Measurement Lab name: _____
System input power: _____ (W)
IES file: _____

Calculation Data

Mounting height: _____ (ft)
Total number of cells: _____
Number of conforming cells: _____
Luminous flux inside all conforming cells: _____ (lm)

LSAE

Luminaire System Application Efficacy: _____ (lm/W)